

SFX RIVAL
OWNER'S MANUAL

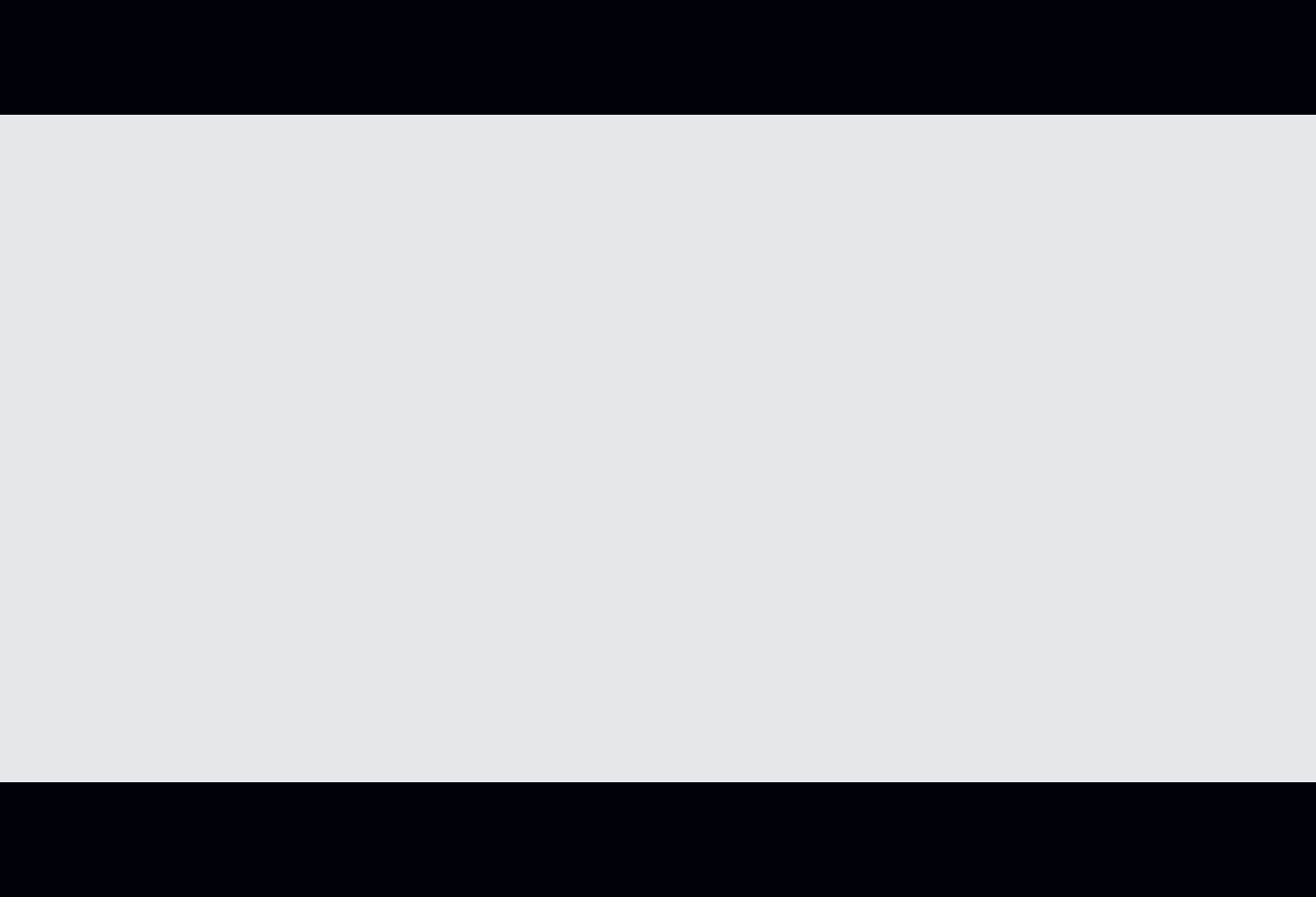

SUPERIOR FIREARMS

CANIK
SUPERIOR FIREARMS



FOREWORD

Congratulations on your purchase of a Canik SFx RIVAL Semi-Automatic pistol, chambered in 9x19mm. With proper care and handling, it will give you many years of long and reliable service.

We specifically disclaim any responsibility for damage or injury whatsoever, occurring as a result of the use of faulty, non-standard or remanufactured ammunition, modifications or changes made to the firearm; improper use or unsafe handling of the firearm.

Always keep this manual with your firearm. Make sure you understand all the warnings, operation instructions and safety procedures. When you lend, give or sell the firearm, be sure this manual goes with it. You can get a copy of this manual from Century Arms or www.canikusa.com

RESPONSIBILITY FOR THE SAFE USE OF FIREARMS LIES WITH THE SHOOTER. ALWAYS TREAT ALL FIREARMS AS IF THEY ARE LOADED AND WILL FIRE AT ALL TIMES!



IMPORTANT!

READ ALL INSTRUCTIONS AND WARNINGS IN THIS BOOKLET BEFORE USING THIS FIREARM.

CONTENTS

Important Safety Message.....	3
Handgun Safety Rules	4
Ammunition Warnings!	8
SFx RIVAL Technical Specifications	10
Handling Responsibilities / Safety.....	11
Loading the Pistol	12
Firing the Pistol.....	14
Unloading the Pistol	15
Field Stripping.....	16
Disassembly	17
Reassembly / Sight Adjustment	18
Installing Mag-Well	19
Removal of Rear Sight Base	20
Optic Sight Interfaces	21
Optic Sight Interface Installation	22
Installing Optic Sights	23
Installing the Cocking Lever	24
Magazine Release Button Extensions.....	25
Changing the Backstrap.....	26
Suppressor Ready Models.....	27
Removing And Installing The Thread Protector.....	31
Cleaning and Maintenance.....	32
Lubrication Warning	33
Warranty	34
Storage.....	35
SFx RIVAL Exploded View	36
SFx RIVAL Parts List	37

⚠ IMPORTANT SAFETY MESSAGE

Children are attracted to and can operate firearms which can cause severe injuries or death. Prevent child access by always keeping gun locked, unloaded and separated from ammunition when not in use. If you keep a loaded firearm where a child obtains and improperly uses it you may be criminally liable.

Firearm Safety Depends on You

A gun is only as safe as the person operating it. You can never be overly careful when handling a firearm. Carelessness is often the cause of shooting accidents, such as failing to keep the muzzle pointed in a safe direction, not being sure of your target and what is behind it, leaving ammunition in the chamber or using improper ammunition. Since a bullet can never be called back once fired, such errors in gun handling can result in the loss of life, severe injury or property damage thus, it is crucial for your safety and the safety of those around you that you learn the principles of safe gun handling and storage before you begin to use your new firearm. Be a safe shooter - please read this instruction book thoroughly even if this is not your first firearm purchase as not all firearms are the same. The first step in being a safe shooter is to learn the rules for the safe operation and handling of firearms. **There is nothing more important in gun handling than safety.**

Safe gun handling depends on you! A safe shooter is a knowledgeable shooter.

Alcohol, Drugs and Guns Don't Mix. Make No Mistake About it!

Never handle firearms after consuming alcohol or taking drugs that can affect your judgment. Shoot sober! Alcohol, certain kinds of drugs and firearms don't mix. Safe firearms handling requires alertness and concentration on one's actions. You cannot handle a firearm safely after consuming alcohol. Never consume anything that can impair your judgment or physical coordination when handling a firearm. Never allow yourself to be distracted while handling a firearm.

HANDGUN SAFETY RULES

The handgun safety rules must be etched into your memory before you begin to handle firearms. These rules are intended to be understood and followed by all persons handling firearms in the field, on the range or at home. Please read, review and understand these rules before you begin to use or even take your new firearm out of its box. Remember, firearms safety depends on you! Memorizing these safety rules will help prevent gun accidents.

⚠ Rule #1

Always Keep the Muzzle Pointed in a Safe Direction

This is the most basic and most important safety rule. A safe direction is one in which an accidental discharge will not cause injury to yourself, to others or property damage. This is particularly important when loading or unloading your firearm. Never point your gun at anything you do not intend to shoot. Treat every gun as if it is loaded at all times.

⚠ Rule #2

Firearms Should Be Unloaded When Not Actually in Use

Firearms should only be loaded when you are in the field or on the target range or shooting area, ready to shoot. When not in use, firearms and ammunition should be secured in a safe place, separate from each other. Remember to unload your firearm completely so that there is no ammunition in the chamber or magazine. Before handling this or any firearm, or handing it to someone else, visually check the chamber and magazine to ensure they do not contain ammunition. Always keep the gun's action open when not in use. Never assume a gun is unloaded. Even if you were the last person to use it. Never cross a fence, climb a tree, wade through a stream or perform any awkward movement with a loaded gun. Never lean or place a firearm where it could fall. When in doubt, unload your gun! Never pull or push a loaded firearm toward yourself or another person. Never carry a loaded gun in a scabbard, a holster not being worn or a gun case - common sense prevails in gun safety!

⚠ Rule #3

Don't Completely Rely on Your Gun's Safety

Treat every gun as though it could fire at any time, even if you are not applying pressure to the trigger. The "safety" on a firearm is a mechanical device which, like any such device, can become inoperable at the worst possible time and fail to function. A safety cannot protect you if you think your gun is unloaded when there is actually a round of ammunition in it. The safety serves as a supplement to proper gun handling but cannot serve as a substitute for common sense. Never handle a gun carelessly and assume that the gun won't fire just because it has a safety. Never touch the firearm's trigger until you are ready to shoot. Keep your fingers away from the trigger when loading or unloading. Never place your finger on the trigger unless you intend to fire."

⚠ Rule #4

Be Sure of Your Target and What Is Beyond it!

Once fired, a bullet can never be called back; so before you shoot, know where the bullet is going and what it will strike. Be certain your shot will not injure someone or strike something beyond the target. Never fire in the direction of noise, a movement or at any object you cannot positively identify. Make sure your shot has a safe backstop such as a hillside. Keep in mind how far the bullet will travel if it misses your intended target. Never shoot a hard surface or water as the projectile may glance or ricochet in an unpredictable direction. Once fired, a bullet can never be called back. You are responsible for your actions and judgment.

⚠ Rule #5

Use the Correct Ammunition

Every firearm is designed to use a certain caliber or gauge of ammunition. It is important that you use the correct ammunition for your firearm. Information on the correct ammunition to use with your firearm appears on the barrel or on the firearm. Use of the wrong ammunition, overpressure ammunition, improperly reloaded ammunition, or corroded ammunition can result in the destruction of the firearm, serious personal injury and/or death. Develop the habit of examining every round of ammunition before you put it into your gun to ensure it is of the proper gauge or caliber and that it is in good condition.

⚠ Rule #6

If Your Gun Fails to Fire When the Trigger Is Pulled, Handle With Care

If a cartridge does not fire when the trigger is pulled, follow Rule #1 and keep the firearm's muzzle pointed in a safe direction. Keep the muzzle down range with the action closed and wait at least 30 seconds (to ensure that the ammunition is not delayed in firing) before carefully opening the action, while avoiding exposure to the breech, unload the firearm and safely disposing of the ammunition.

⚠ Rule #7

➤ Always Wear Eye and Ear Protection When Shooting and Assembling/Disassembling Your Pistol

Exposure to shooting noise can permanently damage hearing. Flying debris, such as powder residue and ejected cartridge cases, can injure your eyes. Thus, it is only common sense to wear both eye protection (such as shooting glasses) and ear protection (such as a sound-muffling headset) whenever shooting. Also, wear eye protection when cleaning or disassembling your gun to ensure that cleaning solvent and tensioned parts (such as springs) do not come into contact with your eyes.

⚠ Rule #8

Be Sure the Barrel Is Clear of Obstructions before Shooting

Discharging a firearm with an obstruction in the barrel can result in personal injury, property damage and/or death. Before you load your firearm, check the chamber and magazine to make certain that no ammunition is inside. Also, check the inside of the barrel (called the "bore") to ensure it is free of obstructions. Even a small amount of mud, snow or excess lubricating oil or grease in the bore can cause excessive pressures resulting in a bulged or burst barrel which can injure or kill the shooter and bystanders. It is a good idea to make a habit of cleaning the bore and checking for obstructions with a cleaning rod just before each shooting session. If the noise or recoil experienced upon firing seems low or weak, or something doesn't feel "right," cease firing immediately and carefully check to make sure that there is no obstruction in the barrel. An obstruction can also be created by attempting to load a smaller caliber of ammunition into your firearm.

⚠ Rule #9

Do Not Alter or Modify Your Gun and Have it Serviced Regularly

Firearms are complex mechanisms that are designed to function properly in their original condition. Any alterations or changes made to a firearm after its manufacture can make the gun unsafe and will void its warranty. Accessories to customize your pistol are available from the Canik Official Accessory Program and the accessories should be installed by a qualified and competent gunsmith. Installation of anything other than a Canik Accessory Program part will void the pistol warranty and may result in damage to the pistol or injury or death.

Do not jeopardize your safety or the safety of others by altering the trigger, mechanical safety or other mechanisms of your firearm. You should have your firearm periodically checked for proper functioning and serviced by a qualified gunsmith.

⚠ Rule #10

Learn the Mechanical and Handling Characteristics of Your Firearm

Not all firearms operate the same way. The method of carrying, handling and operating firearms varies with the mechanical characteristics of each gun. Thus, you should never handle any firearm until you become familiar with the safe handling, loading, unloading and carrying procedures for that particular firearm, as well as the rules for safe gun handling in general.

 **LEAD WARNING!**

Discharging firearms in poorly ventilated areas, cleaning firearms or handling ammunition may result in exposure to lead and other substances known to cause birth defects, reproductive harm and other serious injuries. Have adequate ventilation at all times when shooting. Wash hands thoroughly after exposure.

 **WARNING:** THIS PRODUCT CAN EXPOSE YOU TO CHEMICALS INCLUDING LEAD, WHICH IS KNOWN TO THE STATE OF CALIFORNIA TO CAUSE CANCER AND BIRTH DEFECTS OR OTHER REPRODUCTIVE HARM. FOR MORE INFORMATION GO TO WWW.P65WARNINGS.CA.GOV

 **AMMUNITION WARNINGS!**

THIS PISTOL IS INTENDED FOR USE WITH AMMUNITION MANUFACTURED TO NATO, CIP AND SAAMI STANDARDS. USE OF ANY OTHER AMMUNITION MAY RESULT IN DAMAGE TO THE PISTOL, INJURY OR DEATH.

 **WARNING! STOP SHOOTING IMMEDIATELY AND UNLOAD YOUR FIREARM**

If your firearm develops a mechanical malfunction; binding or stoppage, spitting powder/gas, a cartridge primer is punctured, a cartridge case is bulged or ruptured, or the sound on firing does not sound quite right. Do NOT try to shoot another round, instead unload your firearm and take it and the ammunition to a qualified gunsmith or send it back to Century Arms for examination. Do not assume that the firearm is empty merely because you checked the chamber. You must also check the bore for any obstruction inside the barrel. After unloading, you must disassemble the pistol and check the bore from the breech end before continuing to shoot.

 **WARNING!** Always ensure that the ammunition you are using is clean, undamaged and of the proper caliber before loading your pistol. The manufacturer and distributor of this pistol disclaim any liability for the use of remanufactured, over-pressure, reloaded or hand-loaded ammunition. Protect your investment in this fine firearm by using only factory fresh, quality ammunition. The use of improper caliber or low quality ammunition could result in injury, death and/or property damage upon firing. Remember, firearm safety depends on you.

Diagram showing major operational parts of the SFx RIVAL Semi-Auto Pistol

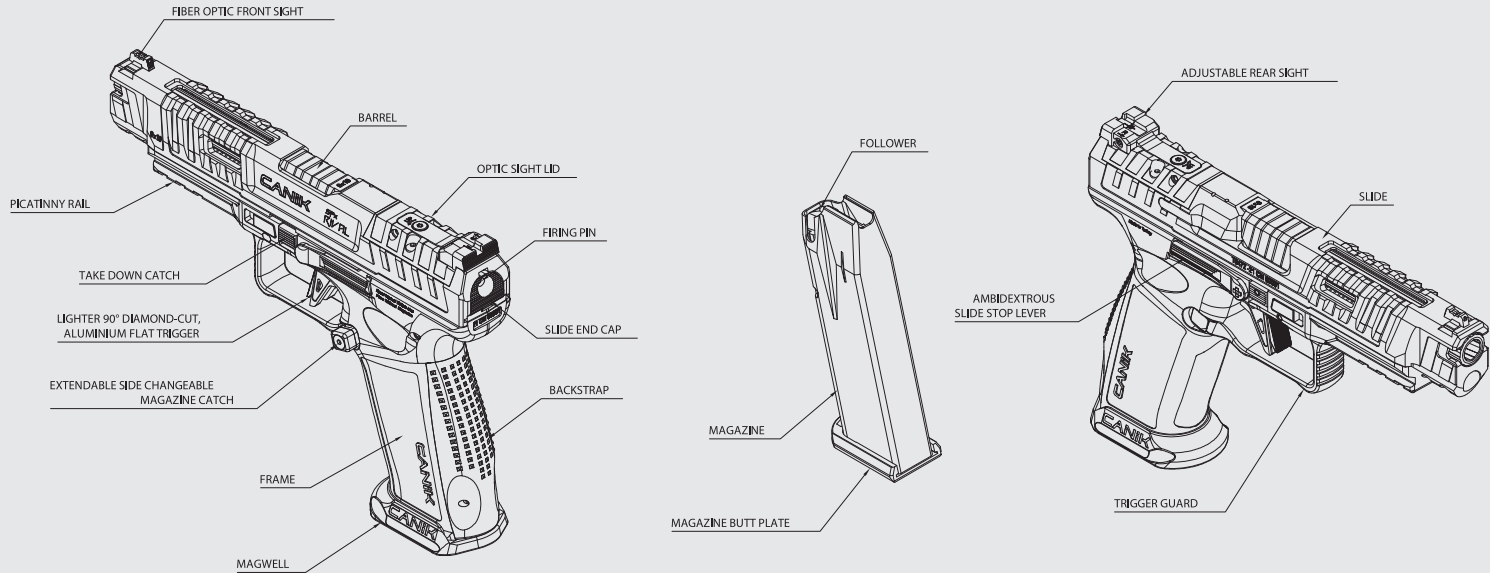

Illustration # 1

The study of this picture will aid you in understanding the instructions in this booklet

SFx RIVAL TECHNICAL SPECIFICATIONS

MODEL	SFx RIVAL				
Caliber	9x19mm				
Magazine Capacity	2x18rds with Aluminum Baseplate				
Barrel Length	127mm - 5.00"				
Overall Length	205.5mm - 8.09"				
Height	145mm - 5.70"				
Width	36mm -1.41"				
Weight (w/18r Empty Magazine)	835g. ±4g / 29.5 oz. ±0.14oz				
Operating System	Single Action				
Fire Control	Striker Fired				
Safety System	Trigger Safety Lever, Firing Pin Block				
Magazine Release	Side Reversible and Extendable (S, M, L)				
Striker Status Indicator	Firing Pin(Striker) is visible when cocked				
Interchangeable Backstrap (Mag-Well Ready)	2 sizes Included				
Mag-Well	Included				
Sights	Click Adjustable Rear Sight, Fiber Optic Front Sight				
Optic Plates	#01: MECANIK® MO2, Docter®, Meopta®, Insight and® Vortex® Viper and More Identical Footprints	#02: Trijicon® RMR and More Identical Footprints	#04: MECANIK® MO1, Shield®, J Point®, Leupold® Delta Point Pro and More Identical Footprints	#06: Works with Sig Sauer® Romeo3 and C-MORE® RTS-2 and More Identical Footprints	#04C: MECANIK® MO1, Shield®, J Point® and More Identical Footprints
Slide Release	Ambidextrous				
Rail	Accessory Under-Barrel Rail				

Included Optic Sight Interfaces may vary based on model configuration.

Handling Responsibilities

1. Always keep the muzzle pointed in a safe direction.
2. Firearms should be unloaded when not actually in use.
3. Don't totally rely on your gun's safety.
4. Be sure of your target and what is beyond it.
5. Use the correct ammunition for your firearm.
6. If your gun fails to fire when the trigger is pulled, handle with care.
7. Always wear eye and ear protection when shooting and cleaning.
8. Be sure the barrel is clear of obstructions before shooting.
9. Don't alter or modify your firearm and have your firearm(s) serviced regularly.
10. Learn the mechanics and handling characteristics of the firearm you are using. Safe gun handling depends on you! A safe shooter is a knowledgeable shooter.

Safety

This pistol has an internal firing pin block, which blocks the firing pin from moving forward unless the trigger is pulled and a trigger safety that must be depressed to pull the trigger.

⚠ Loading the Pistol

1. Load the magazine with the correct ammunition by pressing the cartridges one at a time down and under the magazine's feed lips; the cartridges will automatically alternate from side to side. Holding the magazine in your primary hand and gently tapping it against your opposite palm will help seat the cartridges and assure good feeding. When loading the rounds into the magazine, ensure the base of the cartridge is in contact with the back of the magazine. **(See Illustration #2)**
2. Keeping your finger outside the trigger guard, pick up the firearm with one hand and the magazine with the other. Insert the magazine into the magazine well and tap up on the magazine with adequate force to insure proper seating. **(See Illustration #3)**

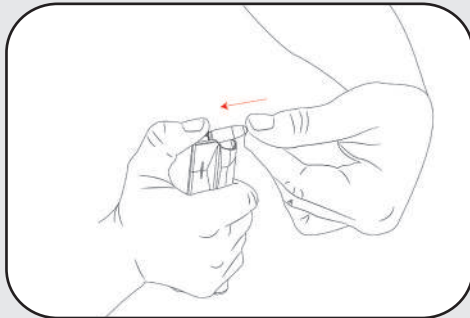

Illustration # 2

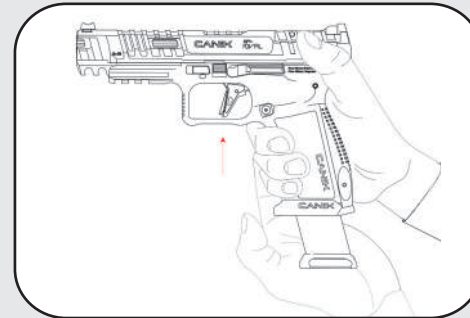

Illustration # 3

3. While maintaining a safe muzzle direction and with your finger off the trigger, pull the slide completely rearwards and release it. As it moves rapidly forward under spring pressure, the slide will strip a round from the magazine and load it into the chamber. **(See Illustration #4)** The pistol is now loaded and ready to fire. **The red striker indicator will be visible. (See Illustration #5)**

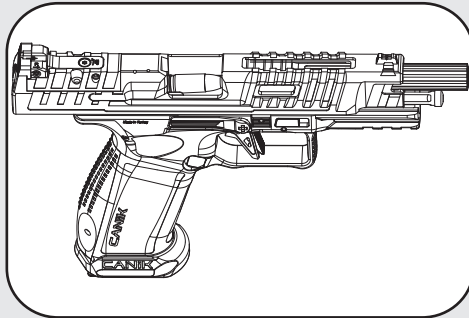

Illustration # 4

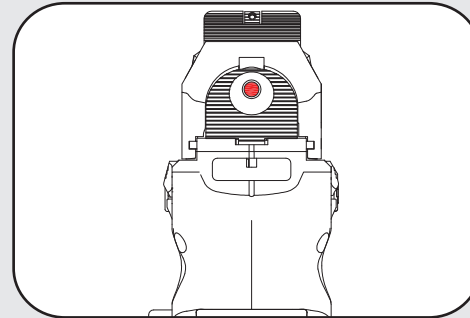

Illustration # 5

- ⚠ WARNING!** The pistol is now loaded and will fire if the trigger is pulled! Handle with extreme caution and keep the muzzle (the end of the barrel) pointed in a safe direction!
- ⚠ WARNING!** The striker indicator is filled with red paint. Over time, the red paint may wear and fade away. The cocking indicator is intended as a visual aid. You must still follow all safe handling rules whether you believe the pistol is cocked or uncocked.

Firing the Pistol

1. Keeping the **Firearm Safety Rules** in mind, aim the pistol downrange at the target. When firing this pistol you may need to experiment with different shooting styles until you find the method which best suits your sporting activity. Always remember to fire the pistol in such a manner that you can maintain a safe muzzle direction at all times.
2. Place your finger inside the trigger guard and on the trigger. Slowly pull the trigger while depressing the trigger safety fully and continue pulling until the striker releases.
3. Being a semi-automatic pistol, the pistol's action (its moving parts) will cycle after the first round is fired. As the slide moves rearwards, the extractor will pull the empty cartridge case from the chamber and eject it from the pistol. (Make sure there are no bystanders in close proximity on either side of the pistol who could be injured by the ejected cartridge case or gasses expelled from the pistol.) The slide moves rearward upon firing, avoid having fingers or hands in the path of the slide's rearward motion.
NOTE: If the trigger is pressed again, the pistol will fire! Keep the pistol pointed in a safe direction. Keep your fingers away from the muzzle when firing the gun.
4. Firing may be continued in this manner until the magazine is empty.

⚠ WARNING! The barrel will be very hot after firing!

⚠ WARNING! Keep all parts of your body away from the muzzle!

⚠ WARNING! Always unload your pistol immediately after use and prior to cleaning and storing to minimize the risk of an accidental discharge.

⚠ WARNING! If your pistol ever fails to fire, keep it pointed at the target for at least 30 seconds in the event of a hang fire (slow ignition). If the round still does not fire, remove the magazine, and while avoiding exposure to the breech eject the cartridge by carefully opening the slide. Discard the faulty round. Reload the pistol to resume firing

Unloading the Pistol

⚠ WARNING! Keep muzzle pointed in a safe direction.

1. While keeping the pistol pointed in a safe direction, hold the pistol with one hand, depress the magazine release button with your thumb and the magazine should fall into your free hand. **(See Illustration #6)**
2. Grasp the slide under the rear sight and move it fully rearward, holding the slide fully open inspect the chamber to ensure it is empty. With the magazine out of the pistol repeat the process of retracting the slide to confirm that no cartridge remains in the chamber, you can confirm this visually and by feel with your little finger.
3. Allow the slide to go forward on the empty chamber. While pointing the pistol in a safe direction pull the trigger to lower the striker. Note: When the striker is lowered, the red striker indicator is not visible. **(See Illustration #5)**

⚠ WARNING! The pistol will fire if the magazine is removed and if the trigger is pulled when a cartridge is in the chamber.

⚠ WARNING! If the pistol is dropped or subjected to an impact, have the pistol's safety systems checked by a gunsmith familiar with Canik products before further use.

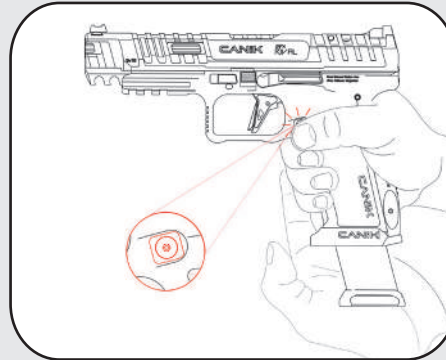

Illustration # 6

Field Stripping

- ⚠ WARNING!** Before beginning the disassembly process, check to ensure the pistol is not loaded. To do so, follow the procedures detailed in the Unloading the Pistol section on **page 15**.
- ⚠ WARNING!** Wear eye protection, such as shooting glasses or goggles, when disassembling your firearm to protect your eyes from chemicals and tensioned parts, such as springs that could be dislodged during disassembly.
1. While remembering to maintain a safe muzzle direction, secure the unloaded pistol firmly in a supported location such as your lap, or on a table. Pull the trigger to lower the striker. Note: When the striker is lowered, the red striker indicator is not visible. **(See Illustration #5)**
 2. While holding the pistol in your primary hand, grasp the take down catches, located above the trigger. Pull them down using index finger and thumb of your secondary hand. At the same time using the thumb of your primary hand push the slide forward. **(See Illustration #6, #7 and #8)** (Please note the slide will only move forward about 1 inch) Lift the slide up until it is free of frame. **(Illustration #9)**

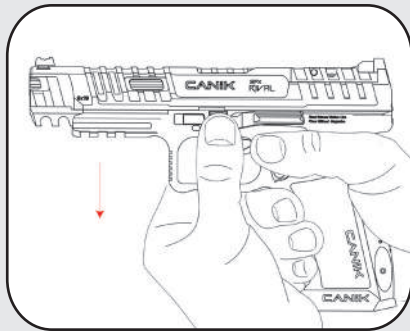

Illustration # 7

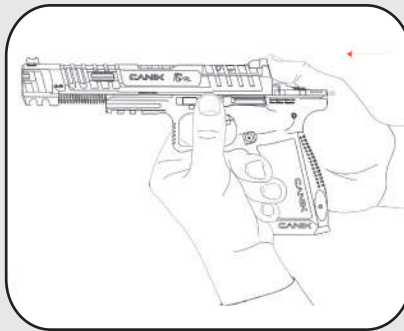

Illustration # 8

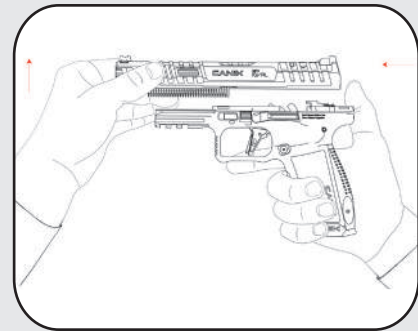

Illustration # 9

Disassembly

1. Holding the slide with primary hand, use your secondary hand to push the recoil spring toward the muzzle and lift it free. (See **Illustration #10**)
2. Lift the barrel slightly and push it forward toward the muzzle. Then you can pull it back and lift it free from the slide. (See **Illustration #11**)

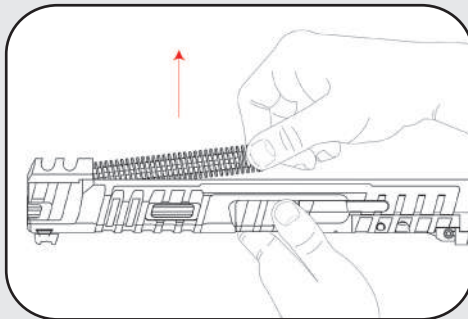

Illustration # 10

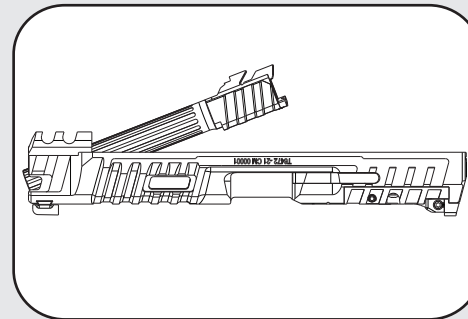

Illustration # 11

⚠ WARNING! Threaded muzzle protector must be taken off before disassembly.

Reassembly

1. Hold the slide in your primary hand with the muzzle side facing the ground. Drop the barrel into the slide, turn the slide up so that the muzzle now is facing the sky. The barrel will fall into place.
2. While holding the slide in your primary hand, place the recoil spring in the muzzle end of the slide. **NOTE: The flat end of the recoil spring must be facing the chamber.** (See Illustration #12) Use your thumb on your secondary hand to press the spring towards the muzzle and slightly down.
3. Line the slide grooves up with the frame and slide them back together.

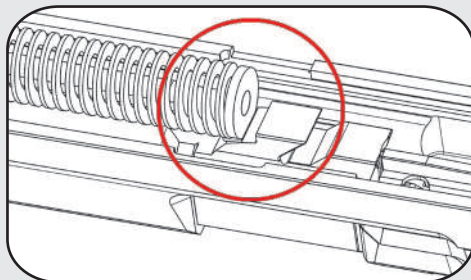

Illustration # 12

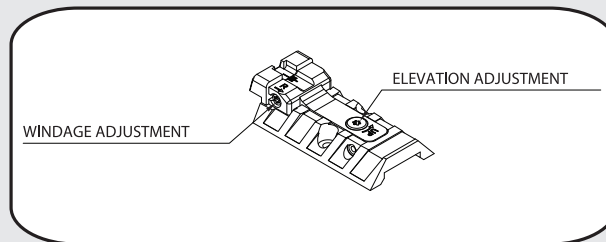

Illustration # 13

Sight Adjustment

1. The rear sight is windage and elevation adjustable. If the bullet hits to the right of point of aim (POA), move the rear sight left. If the bullet hits left of POA, move rear sight right. If the bullet hits low of point of aim (POA), move the rear sight up. Adjust to desired direction by screws and arrows on the adjustable rear sight. (See Illustration #13)
2. The front sight is also drift windage adjustable as the rear sight.
CAUTION! Only use T10 Torx Key for Windage and Elevation Adjustment.

Installing Mag-Well

⚠ WARNING! Before beginning the disassembly process, check to ensure the pistol is not loaded. To do so, follow the procedures detailed in the Unloading the Pistol section.

1. Remove the magazine from the pistol and confirm the chamber is not loaded.
2. Slide the mag-well into the mag-well rail protrusions at the bottom of the frame starting from front to the rear as shown in **Illustration #14**. Ensure the rails of the mag-well are seated to the frame and the holes on the mag-well and the frame meet. Then tighten the mag-well by using the Torx key (T10) as shown in **Illustration #15**.

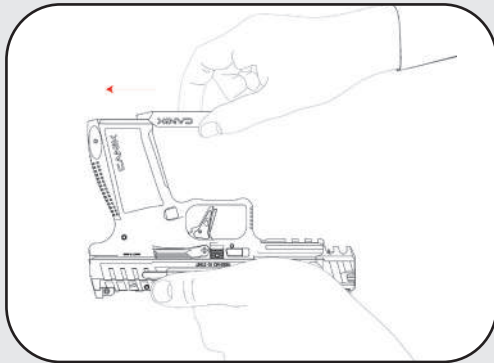

Illustration # 14

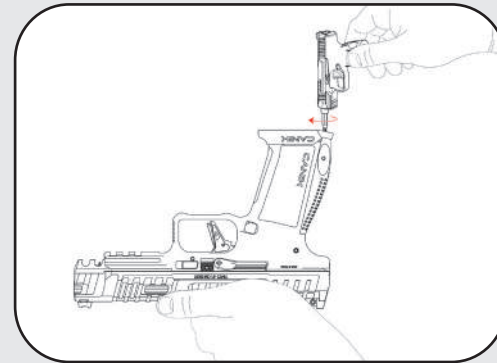

Illustration # 15

Note: Mag-Well might be an accessory and may not be available in your package content.

Removal of Rear Sight Base

- ⚠ WARNING!** Adjustable Rear Sight is integrated with the Rear Sight Base and it is highly recommended not to remove the Adjustable Rear Sight component from Rear Sight Base.
 - ⚠ WARNING!** Before beginning the disassembly process, check to ensure the pistol is not loaded. To do so, follow the procedures detailed in the Unloading the Pistol section.
 - ⚠ WARNING!** Wear eye protection, such as shooting glasses or goggles, when disassembling your firearm to protect your eyes from tensioned parts, such as springs that could be dislodged during disassembly.
1. Before beginning, remove all live ammunition, loaded magazines and other firearms from the working area. Remove the magazine from the pistol. To do so, follow the procedures detailed in the, unloading the Pistol section and confirm the chamber is empty.
 2. Holding the pistol as shown in **Illustration #16** Use a Torx key (T10) to remove the Rear Sight Base Screws.
 3. After removing the Rear Sight Base Screws with Lock Washers, lift the sight base up as shown in **Illustration #17**- Please note that as the base fits extremely tight, you may need to follow the directions under Field Stripping to remove the slide. Once the slide has been removed use the Torx key (T10) in the screw hole pictured in **Illustration #18** and push to unseat the rear sight base. Prying the rear sight base off may damage the base and/or the slide.

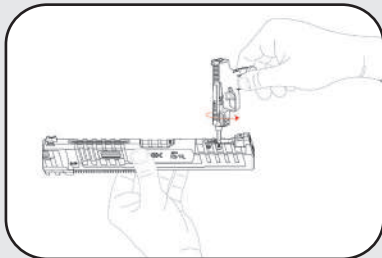

Illustration # 16

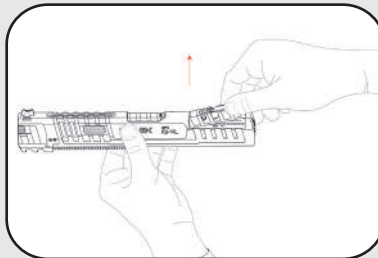

Illustration # 17

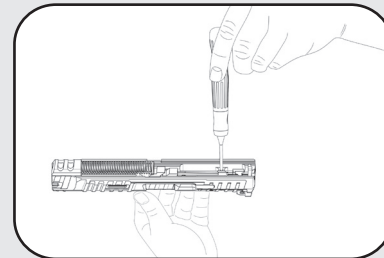

Illustration # 18

Optic Sight Interfaces

Your SFX RIVAL comes with the most popular Optic Sight Interfaces. (See Illustration #19).

The set includes a Torx Key (T10), two Optic Sight Interface screws and two spare screws for the Optic Sight Interfaces

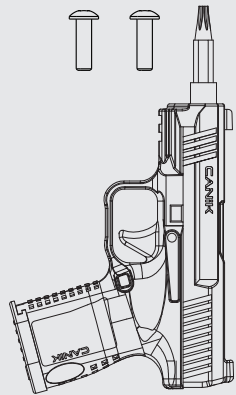

Illustration # 19

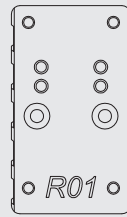

Plate 01
Works with
MECANIK®
MO2, Docter®,
Meopta®,
Insight and®
Vortex® Viper
and Identical
Footprints

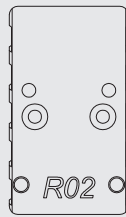

Plate 02
Works with
Trijicon®
RMR and
Identical
Footprints

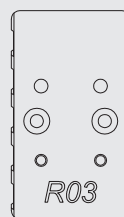

Plate 03
Works with C-
More® STS
and Identical
Footprints

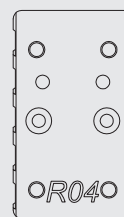

Plate 04
Works with
MECANIK®
MO1, Shield®, J
Point®, Leupold®
Delta Point Pro
and Identical
Footprints

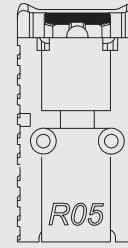

Plate 05
Works with Acro®
C1 and Identical
Footprints

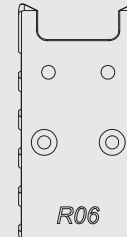

Plate 06
Works with Sig
Sauer® Romeo3
and C-MORE®
RTS-2 and
Identical
Footprints

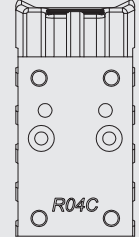

Plate 04C
Works with
MECANIK®
MO1,Shield®
Sig Sauer® Romeo Zero,
Vector Optics® and
More Identical Footprints

Included Optic Sight Interfaces may vary based on model configuration but all of these interfaces are compatible with both SFX Rival configurations.

Included in the SFX Rival **Dark Side** Configuration: **Plates 1, 2, 4, 6 and R04-c**

Included in the SFX Rival **Gray** Configuration: **Plates 1, 2, 4 and 6**
Plates 3, 5 sold separately.

Only use the interface screws that are included with your pistol to install Optic Sight Interface bases.

Optic Sight Interface Installation

⚠ WARNING! Before beginning the disassembly process, check to ensure the pistol is not loaded. To do so, follow the procedures detailed in the Unloading the Pistol section.

Insert the Sight Interface as shown in **Illustration #20**. Using the Optic Sight Interface screws that come with your pistol, tighten the screws with using Torx Key (T10) (**See Illustration #21**).

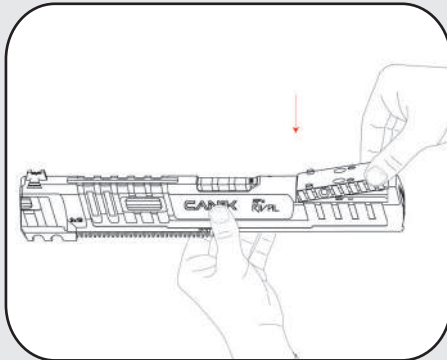

Illustration # 20

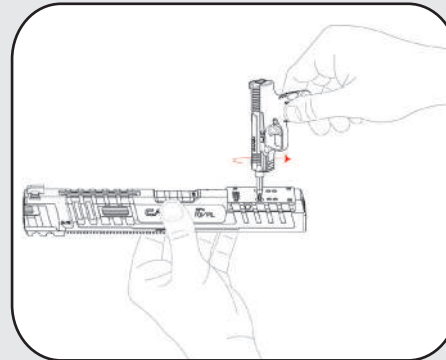

Illustration # 21

Installing Optic Sights

- ⚠ **WARNING!** Before beginning the disassembly process, check to ensure the pistol is not loaded. To do so, follow the procedures detailed in the Unloading the Pistol section.
 - ⚠ **WARNING!** Wear eye protection, such as shooting glasses or goggles, when disassembling your firearm to protect your eyes from tensioned parts, such as springs that could be dislodged during disassembly.
1. Use Torx key (T10) to remove the optic sight lid screws.
 2. After removing the optic sight lid, install the interface and make sure that it fits properly into the sockets on your slide as shown in **Illustration #22** and screw the optic sight on using Torx key (T10) through the interface as shown in **Illustration #23**. Only use the screws included with your Canik pistol to mount an optic.

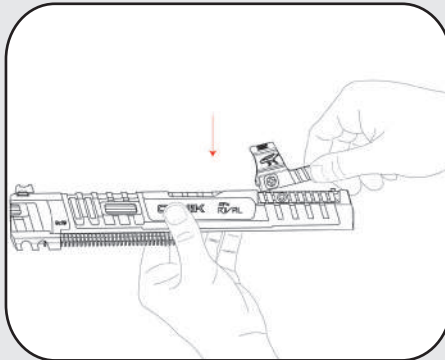

Illustration # 22

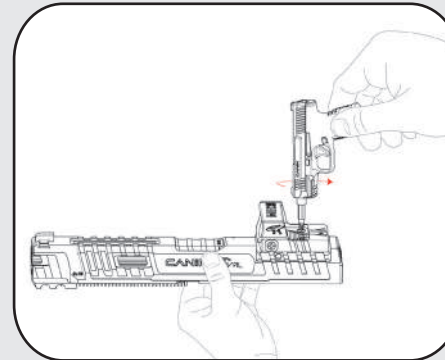

Illustration # 23

Installing the Cocking Lever

⚠ WARNING! Before beginning the disassembly process, check to ensure the pistol is not loaded. To do so, follow the procedures detailed in the Unloading the Pistol section.

Screw the Cocking Lever into its socket located on the side of the Optic Sight Interface as shown in **Illustrations #24 & #25**. The cocking handle can be mounted for either right or left handed operation. By using a screw driver as shown in **Illustration #25**, tighten the Cocking Lever.

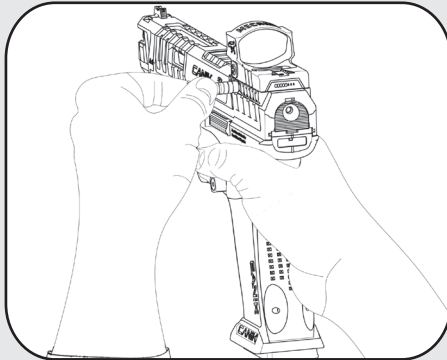

Illustration # 24

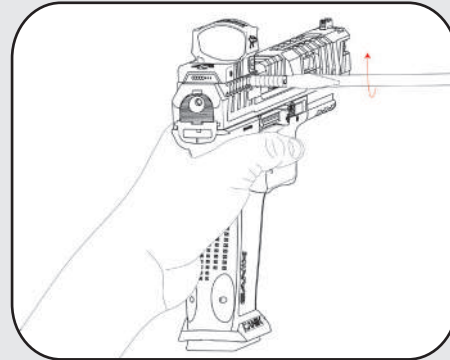

Illustration # 25

Magazine Release Button Extensions

⚠ WARNING! Before beginning the disassembly process, check to ensure the pistol is not loaded. To do so, follow the procedures detailed in the Unloading the Pistol section.

Your pistol may come with three different size Magazine Release Button Extensions (small - medium - large). If so, select the size of magazine release extension that best suits your needs. Remove the screw using the included Torx key (T10) wrench, insert the release and tighten the Torx key (T10) as shown **Illustration #26**.

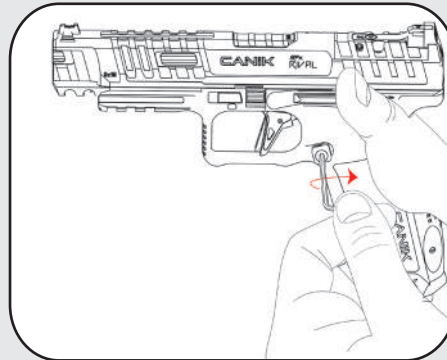

Illustration # 26

Changing the Backstrap

- ⚠ WARNING!** Before beginning the disassembly process, check to ensure the pistol is not loaded. To do so, follow the procedures detailed in the Unloading the Pistol section. Remove the magazine from the pistol and confirm that the chamber is unloaded.
1. Before beginning, remove all live ammunition, loaded magazines and other firearms from the working area.
 2. Use the CANIK Punch included in the package content to push out the Backstrap Pin.
 3. After installing the Backstrap, make sure that it fits properly to the Frame.
 4. Re-insert the Backstrap Pin and ensure that the Backstrap Pin is centered. Use the CANIK Punch to push in the Backstrap Pin as shown in **Illustration #27**

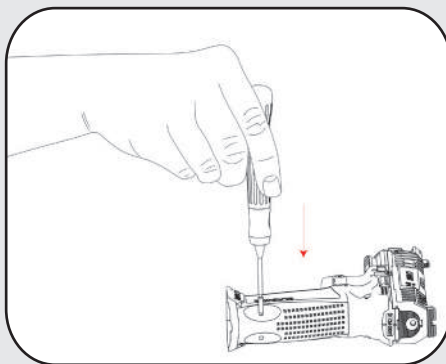

Illustration # 27

Suppressor Ready Models

- ⚠ WARNING!** Follow all instructions provided by the suppressor manufacturer.
- ⚠ WARNING!** Before beginning the disassembly process, check to ensure the pistol is not loaded. To do so, follow the procedures detailed in the Unloading the Pistol section. Remove the magazine from the pistol and confirm that the chamber is unloaded.
- ⚠ WARNING!** Wear eye protection, such as shooting glasses or goggles, when disassembling your firearm to protect your eyes from tensioned parts, such as springs that could be dislodged during disassembly.
- ⚠ WARNING! 1: THREADED MUZZLE** Your pistol is equipped with a threaded barrel for suppressed applications. The thread on the barrel is designed to a specific suppressor or muzzle device thread pattern (M13, 5 LH or 1/2-28 RH). Attempting to install a device with any thread pattern other than the barrel's specific thread pattern will result in destruction to your pistol and/or suppressor, and could result in personal injury. The threaded barrel is provided with a thread protector cap. Carrying or discharging the pistol without a suppressor or without the cap installed may lead to damaged barrel threads.
- Never attempt to attach a suppressor to muzzle threads that are dirty or damaged, as this may lead to damage to the firearm or suppressor, as well as property damage, personal injury, and/or death.
- Suppressor ready models of Canik/Century Arms should only be used with high quality sound suppressors, compensators and other accessories. Use of low quality suppressors and use of a suppressor in a manner inconsistent with the manufacturer's instructions can damage or cause excessive wear on pistol components and void the Canik limited lifetime warranty.
- ⚠ WARNING! 2: INSTALLATION** Never install, tighten or remove a suppressor from a loaded firearm.
- To properly install a suppressor, point the pistol in a safe direction and confirm that the magazine is removed. Next, open the slide and confirm that no cartridge remains in the chamber. Follow the suppressor instructions for proper installation.
- Generally, a suppressor must be hand tight on the barrel. If a suppressor is over-tightened, threads on the barrel or suppressor can be stripped or the suppressor can be misaligned with the bore. Unless the suppressor is properly aligned with the bore axis, do not fire the pistol. Firing a pistol with an improperly installed or misaligned suppressor will result in destruction of the pistol and suppressor and may cause injury or death. Check the fit between barrel and suppressor before firing! The thread mount must be fully engaged on the barrel. If there is any gap **DO NOT FIRE** with the suppressor attached. Poor accuracy and product damage may result if the suppressor is not fully engaged.
- Failure to follow installation and maintenance instructions detailed in the manual for the suppressor may result in serious personal injury and damage to the weapon. Firearm sound suppressors are user-attached firearm muzzle devices, and as such are subject to improper attachment issues unless the procedures outlined in the suppressor manual are followed precisely. Do not attempt to use the pistol with the suppressor unless you have specific training and experience in the use of suppressed firearms.

- ⚠ WARNING! 3: SUPPRESSORS ABSORB ENERGY AND BECOME HOT DURING FIRING** Contact with a suppressor during or after firing will cause significant skin burns and will damage heat sensitive objects. Identify an appropriate location to rest your suppressed firearm after firing to maintain a safe muzzle direction and to avoid burns. Touching a hot suppressor with bare skin may result in injury. Never hold the suppressor during firing.
- ⚠ WARNING! 4: REMOVAL OF THE SUPPRESSOR** Before removing the sound suppressor from the firearm confirm that the pistol is unloaded and the action is opened so that it is visually clear of any ammunition. If you are unsure as to the proper procedures to ensure that your firearm is unloaded, follow the procedures detailed in the Unloading the pistol section and confirm the chamber is empty.
- ⚠ WARNING! 5: SUPPRESSOR MAINTENANCE** Assembly and disassembly of the pistol or suppressor should never be performed while the suppressor is affixed to the firearm. Always completely remove the suppressor from the firearm before assembly and/or disassembly is attempted. Before performing maintenance, removing, or installing the suppressor, open the action, ensure firearm is unloaded, and be sure the chamber is empty. Failure to do so can result in property damage, injury, or death. Follow all suppressor manufacturer instructions regarding proper cleaning, maintenance and lubrication for your suppressor.
- ⚠ WARNING! 6: TIGHTENING** If during firing your suppressor loosens, completely unload the pistol and confirm that the chamber is empty. Allow the suppressor and pistol to cool before tightening the installation. Do not attempt to fire the pistol with a loose suppressor as damage to the pistol and suppressor and injury can occur.
- ⚠ WARNING! 7: PROPER CALIBER** Your pistol is chambered for the 9x19mm cartridge. Do not attempt to install and fire with any suppressor which is not designed to fire 9x19mm ammunition.

- ⚠ WARNING! 8: AMMUNITION GUIDELINES** To maximize efficiency and reliability when using firearms with suppressor, it is imperative users **ONLY** employ **FACTORY NEW LOADED** jacketed ammunition. **DO NOT** fire lead bullets, frangible or pre-fragmented ammunition through any Canik/Century Arms firearms with a suppressor installed. Evidence of use of any lead, frangible or pre-fragmented ammunition will void the warranty. To maximize suppressor efficiency and reliability we recommend using factory loaded, jacketed ammunition designed to remain subsonic when fired. Subsonic ammunition will have a muzzle velocity below the speed of sound, and will provide the most pleasing sound signature when fired through the firearm with a mounted suppressor. While Canik/Century Arms firearms are capable of shooting +P ammunition, **ONLY** fire standard pressure (Not +P) ammunition through a suppressor. The use of ammunition other than standard pressure ammunition with suppressors may lead to damage, personal injury and/or death. Follow all instructions and warnings provided by your suppressor manufacturer.
- ⚠ WARNING! 9: EYE PROTECTION** Firing a suppressed firearm changes the pressure profile inside the chamber. This can create a greater number of airborne powder or lead particles around the pistol and the suppressor. Always wear eye protection when discharging firearms with or without a suppressor. Discharging the firearm without wearing eye protection may lead to personal injury and/or death.
- ⚠ WARNING! 10: HEARING PROTECTION** Suppressors do not eliminate the sounds of a discharge. Factors like the type of ammunition fired, the environment where firing, and the operation of the firearm all contribute to firing noise. When firing a suppressor, the shooter and by-standers, must wear hearing protection.

⚠ WARNING! 11: SAFE USE Since suppressors are much quieter when fired than un-suppressed firearms, the shooter must exercise a higher awareness of those near-by. Only the shooter can ensure that individuals and animals do not accidentally intersect the firing impact zone. Because suppressed firearms make less noise than unsuppressed firearms, it is easy to forget that they are still firearms and capable of causing death, bodily injury and property damage. It is of vital importance to remember that a suppressed firearm is just as dangerous as an unsuppressed firearm, and that the same safe handling requirements still apply.

IMPORTANT: Before using any accessories check your local, state and federal laws to insure owning and using sound suppressors, compensators and other accessories are in compliance with these laws.

⚠ WARNING! 12: LEAD WARNING Using, handling and/or cleaning a firearm or suppressor may result in exposure to lead and other substances known to cause birth defects, reproductive harm, cancer and other serious physical injury. Have adequate ventilation at all times and wash hands thoroughly after exposure.

⚠ WARNING! 13: Follow all instructions and warnings provided by your suppressor manufacturers.

Removing and Installing the Thread Protector

⚠ WARNING! Before beginning the disassembly process, check to ensure the pistol is not loaded. To do so, follow the procedures detailed in the Unloading the Pistol section. Remove the magazine and confirm the chamber is unloaded.

Notice! This section only applies to threaded barrel configurations.

By using the wrench that is included with your pistol in the case, you can screw/unscrew the threaded muzzle protector as shown in **Illustration #28**. You can screw threaded muzzle protector by turning the wrench (**Warning!** Thread pitch may vary depending on metric or inch configuration) Counterclockwise (for Metric Barrel-LH) direction and unscrew it by turning the wrench clockwise as shown in **Illustration #29**.

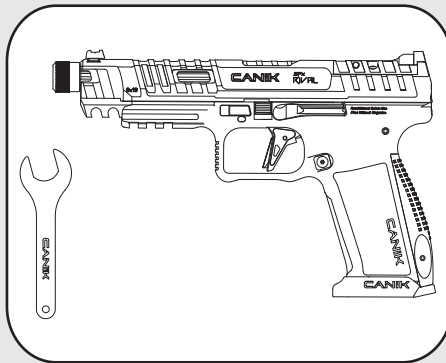

Illustration # 28

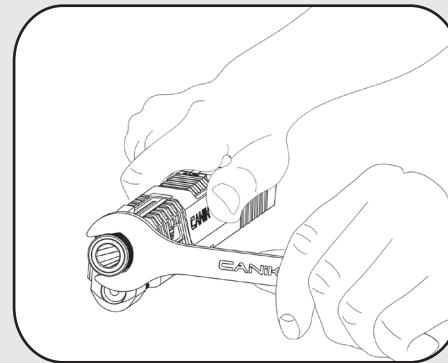

Illustration # 29

Cleaning and Maintenance

- ⚠ WARNING!** Before beginning the cleaning process, check to ensure the pistol is unloaded. (See the **Unloading the Pistol** section). Remove the magazine from the pistol and confirm that the chamber is unloaded.
- ⚠ WARNING!** You should wear eye protection, such as shooting glasses or goggles, when cleaning your firearm to protect your eyes from tensioned parts, such as springs and solvents that may become dislodged during disassembly.
1. Obtain a quality cleaning kit or use the one if supplied within the pistol case in addition to the instructions in this section, follow all instructions provided with the cleaning kit you use as well and warnings provided with lubricants and solvents.
 2. Follow the pistol field stripping procedures.
 3. To clean barrel, select the correct caliber cleaning brush and attach it to the cleaning rod.
 4. Dampen the screw-in nylon bore brush with cleaner, lubricant, protectant (CLP) and then push/pull the brush through the barrel several times from the chamber to the muzzle.
 5. Remove the brush and attach a cloth cleaning patch to the cleaning rod and push it through the barrel several times to remove loosened fouling.
 6. Repeat this process with the brush and cleaning patches until a final patch comes out clean after swabbing the bore. Apply a light coating of CLP to the bore of the barrel.
 7. Remove shooting residue from the slide, barrel's exterior, and action parts using the brush and cloth supplied. Apply a light coating of CLP to the rails, trigger bar and inside of the ejector assembly of frame and rails on the slide and firing pin block together with the slide's inner side where the barrel operates.
 8. Wipe outer surface with a soft cloth dipped in good quality gun oil.
- ⚠ WARNING! MAINTAINING THE FINISH ON YOUR PISTOL** Do not use sandpaper or emery cloth to clean any part of the firearm or suppressor. Abrasives more aggressive than Scotch Brite may damage the precision contact surfaces of the pistol, resulting in friction that can lead to malfunctions of the firearms and suppressor. A malfunctioning firearm or suppressor is a dangerous situation that can lead to property damage, personal injury and/or death. Only use solvents in a well-ventilated area away from open flames.

Unsafe use of solvents may lead to property damage, personal injury and/or death.

Lubrication Warning

Firing a firearm with oil, grease or any other material even partially obstructing the bore may result in damage to the firearm and injury to the shooter and those nearby. Do not spray or apply lubricants directly on ammunition. If the powder charge of a cartridge is affected by the lubricant, it may not be ignited, but the energy from the primer may be sufficient to push the bullet into the bore where it may become lodged. Firing a subsequent bullet into the obstructed bore will damage the firearm and may cause injury to the shooter and those nearby. Use lubricants properly. You are responsible for the proper care and maintenance of your firearm and ammunition.

Warning Concerning Alterations and Aftermarket Parts!

Accessories to customize your pistol are available from the Canik Official Accessory Program part the accessories should be installed by a qualified and competent gunsmith. Installation of anything other than a Canik Accessory Program part will void the pistol warranty and may result in damage to the pistol or injury or death. It is your duty to make sure any parts you buy are made for this firearm and are installed correctly and that neither the replacements nor originals are altered or changed. Your gun is a complex precision tool with many parts that must relate correctly to other parts in order for proper and safe operation. Putting a gun together wrong or with incorrect or modified parts can result in a damaged gun, danger, injury or death to you and others through malfunction. Always have a qualified gunsmith work on your gun or at least check any work not performed by a gunsmith.

Limited Lifetime Warranty

Congratulations on purchasing your Canik Century Arms SFx RIVAL. Century Arms prides itself on being the only certified service provider of SFx RIVAL pistols in the USA. Pursuant to Canik's Limited Lifetime Warranty Policy, Century Arms will repair defects in material or workmanship associated with the firearm without charge to the original purchaser for as long as you own the handgun. (This agreement is not transferable; its benefits apply only to the original documented purchaser. Firearm accessories are not covered under this policy.) Evidence of use of any lead, frangible or pre-fragmented ammunition will void the warranty, and any repairs made necessary from the use of frangible or pre-fragmented ammunition will be invoiced to the owner. Not using a quality suppressor can damage or cause excessive wear on pistol components and void the Canik limited lifetime warranty.

Please send a copy of the Product Registration Form within 30 days of purchase to register your pistol with Canik and Century Arms. Register your product at www.canikusa.com. Proof of purchase, including a receipt or invoice, must be provided with your registration.

To make a repair claim, e-mail: Support@centuryarms.com for instructions on how to return your pistol. Do not return your SFx RIVAL pistol for service without prior authorization.

When contacting customer service, please have the owner's name, address, model and serial number available. This information will help the service representative to expedite your request.

Warranty

The Canik warranty will be void if any of the following occur:

1. The product is not properly registered,
2. The instructions in the manual are not followed,
3. Your SFx RIVAL pistol or any of its parts are altered or modified from their original state,
4. Damage is caused by corrosion, misuse, abuse, or improper maintenance,
5. Your SFx RIVAL pistol is disassembled/assembled beyond the instructions in the manual,
6. Ammunition that is damaged, reloaded, remanufactured, hand-loaded, over pressure or ammunition of a different caliber must never be used in your SFx RIVAL pistol; or
7. SFx RIVAL used for range rentals or other similar programs are not eligible,
8. Using accessories other than Official Canik Accessories.

This warranty does not cover loss, theft, deliberate damage, corrosion, neglect, abuse or unreasonable use, misuse, defects or malfunctions resulting from misuse, ammunition failures or use of defective or improper ammunition, lack of maintenance, non-factory part installations, alterations or modifications to the firearm, disassembly beyond the field stripping instructions in the product's manual (where applicable), normal or ordinary wear and tear, criminal misuse, negligence, use under the influence of drugs or alcohol, or cosmetic damage that does not hinder the performance of the product.

To the full extent permissible by applicable law, Canik, and their employees, agents, distributors and partners do not make, and are not entitled or authorized to make, any warranty of any kind, express or implied with respect to the SFx RIVAL pistols, **INCLUDING WITHOUT LIMITATION ANY WARRANTY OF MERCHANTABILITY OR FITNESS FOR ANY PARTICULAR PURPOSE.** The only limited warranty provided is from Canik, pursuant to terms and limitations stated herein. Nothing contained herein shall be interpreted as an implied or express warranty by Canik beyond the terms above.

CANIK AND CENTURY DISCLAIMS ANY IMPLIED WARRANTIES TO THE FULLEST EXTENT ALLOWABLE BY LAW.

Storage

Your pistol should be thoroughly cleaned and lightly lubricated before being put away for storage. A light coating of good quality gun oil should be applied to all exposed surfaces. Remove all excess lubrication and use a cleaning rod and cleaning patch to make sure that the bore (the inside of the barrel) is dry and free of obstructions when you remove your pistol from storage and before firing it. CHECK TO ENSURE THAT YOUR PISTOL IS NOT LOADED BEFORE STORING IT. ALWAYS STORE FIREARMS AND AMMUNITION SEPARATE FROM EACH OTHER AND OUT OF REACH OF CHILDREN. ALWAYS SECURELY LOCK YOUR FIREARMS AND AMMUNITION IN SEPARATE LOCATIONS WHEN NOT IN USE. REFERENCE YOUR HOME STATE'S FIREARMS REGULATIONS FOR SAFE STORAGE OF FIREARMS AND AMMUNITION.

SFx RIVAL Exploded View

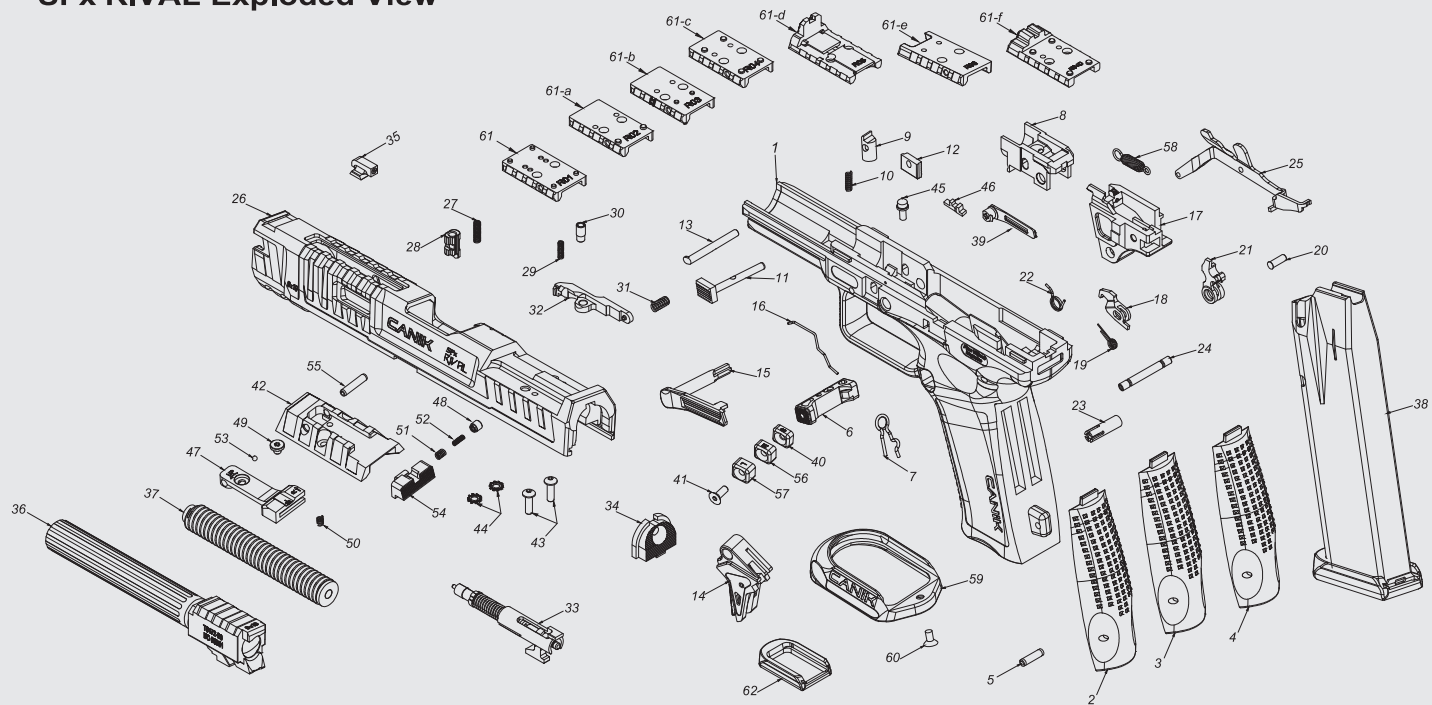

Included Optic Sight Interfaces may vary based on model configuration.
Note: Optic Sight Interface numbered #3 and #5 are sold separately.

SFx RIVAL Parts List

Description	Century Code#	Description	Century Code#	Description	Century Code#
1 FRAME	HF3426-N	28 FIRING PIN BLOCK	PATP032	55 REAR SIGHT BLADE PIN	PATP046Q
2 BACKSTRAP (S)	PATP002R	29 EXTRACTOR PIN SPRING	PATP033	56 MAGAZINE RELEASE BUTTON (M)	PATP004D
3 BACKSTRAP (M)	PATP002Q	30 EXTRACTOR PIN	PATP034	57 MAGAZINE RELEASE BUTTON (L)	PATP004E
4 BACKSTRAP (L)	PATP002S	31 EXTRACTOR SPRING	PATP035	58 TRIGGER SPRING	PATP028
5 BACKSTRAP PIN	PATP003B	32 EXTRACTOR	PATP036	59 MAGWELL	PATP004L
6 MAGAZINE CATCH	PATP55039	33 FIRING PIN ASSEMBLY	PATP039C	60 MAGWELL SCREW M3X6 T10	PATP55007
7 MAGAZINE CATCH SPRING	PATP005	34 SLIDE END CAP	PATP044A	61 OPTIC SIGHT INTERFACE #R1 (Works with MECANIK® MO2, Docter®, Meopta®, Insight and® Vortex® Viper and Identical Footprints)	PATP048D
8 LOCKING BLOCK	PATP006C	35 FRONT SIGHT	PATP047F		
9 LOCKING LEVER	PATP007A	36 BARREL	PATP049W		
10 LOCKING LEVER SPRING	PATP008	37 RECOIL SPRING ASSEMBLY	PATP070	61-a OPTIC SIGHT INTERFACE #R2 (Works with Trijicon® RMR and Identical Footprints)	PATP048E
11 TAKE DOWN CATCH	PATP009A	38 MAGAZINE 18RDS	MA897		
12 TAKE DOWN CATCH PIECE	PATP010B	39 RIGHT SLIDE STOP LEVER	PATP017F	61-b OPTIC SIGHT INTERFACE #R3 (Works with C-More® STS and Identical Footprints)	PATP048F
13 LOCKING LEVER PIN	PATP012B	40 MAGAZINE RELEASE BUTTON (S)	PATP004C		
14 TRIGGER ASSEMBLY	PATP014H	41 MAGAZINE CATCH SCREW	PATP004B	61-c OPTIC SIGHT INTERFACE #R4 (Works with MECANIK® MO1, Shield®, J Point®, Leupold® Delta Point Pro and Identical Footprints)	PATP048G
15 LEFT SLIDE STOP LEVER - 36mm	PATP017E	42 REAR SIGHT BASE - SERRATED	PATP046H		
16 SLIDE STOP LEVER SPRING	PATP018A	43 REAR SIGHT BASE SCREW	PATP045G		
17 EJECTOR	PATP019	44 LOCK WASHER	PATP045P	61-d OPTiK SIGHT INTERFACE #R5 (Works with Acro® C1 and Identical Footprints)	PATP048I
18 SEAR	PATP020	45 TAKE DOWN CATCH DETENT	PATP010A		
19 SEAR SPRING	PATP021	46 LOCKING LEVER PIN DETENT	PATP012C	61-e OPTiK SIGHT INTERFACE #R6 (Works with Sig Sauer® Romeo3 and C-MORE® RTS-2 and Identical Footprints)	PATP048J
20 SEAR PIN	PATP022	47 ADJUSTABLE REAR SIGHT BASE	PATP046I		
21 SEAR LEVER	PATP023A	48 REAR SIGHT BLADE	PATP046J		
22 SEAR LEVER SPRING	PATP024	49 ELEVATION ADJUSTMENT SCREW	PATP046K	61-f OPTiK SIGHT INTERFACE #R4C (Works with MECANIK® MO1, Shield®, J Point® and Identical Footprints)	PATP048H
23 SEAR LEVER PIN	PATP025A	50 ELEVATION SPRING	PATP046L		
24 EJECTOR PIN	PATP026A	51 WINDAGE ADJUSTMENT SPRING - SHORT	PATP046M		
25 TRIGGER BAR	PATP027	52 WINDAGE ADJUSTMENT SPRING - LONG	PATP046N	62 +0 MAGAZINE BUTT PLATE	PATP55071
26 SLIDE	PATP030R	53 Ø1mm BALL	PATP046O		
27 FIRING PIN BLOCK SPRING	PATP031	54 REAR SIGHT	PATP046P		

Included Optic Sight Interfaces may vary based on model configuration.

Note: Optic Sight Interface numbered #3 and #5 are sold separately.

All rights pertaining to any information and statements including designs or pictures contained in this Manual are the property of Samsun Yurt Savunma Sanayi ve Ticaret A.Ş. and all rights are reserved. Unless prior written approval is granted by Samsun Yurt Savunma Sanayi ve Ticaret A.Ş, this Manual or any information contained herein may not be copied, published, distributed, transmitted by any means, leased, modified, made subject to sub-licensing or used for any purposes.

CANİK is the registered trademark of Samsun Yurt Savunma Sanayi ve Ticaret A.Ş.



This user manual has been approved by Canik Academy.

CANİK
SUPERIOR FIREARMS



**CENTURY
ARMS**

SFx Rival
Semi - Auto Pistols
Cal. 9x19mm
Distributed by: Century Arms
236 Bryce Boulevard, Fairfax, VT 05454

www.centuryarms.com

Sales Tel: 1.800.527.1252 - 1.561.265.4530
Sales Fax: 1.561.265.4520

www.centuryarms.com

C55.95-KK-EN-21-80-d